

Fig. 1

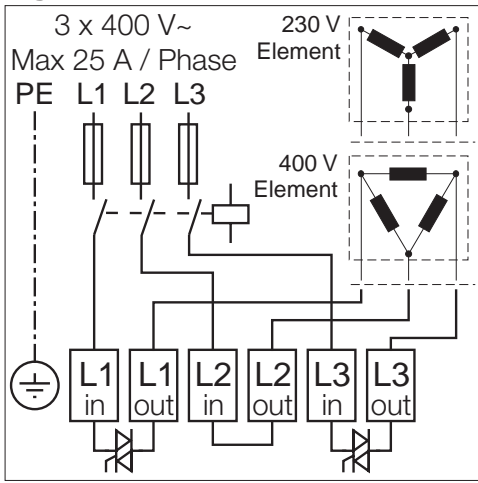

Fig. 2

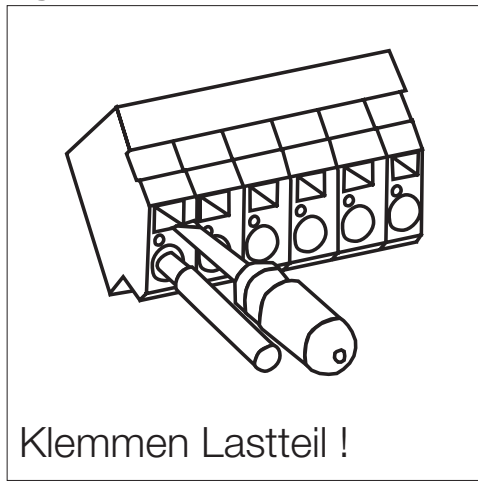

Fig. 3

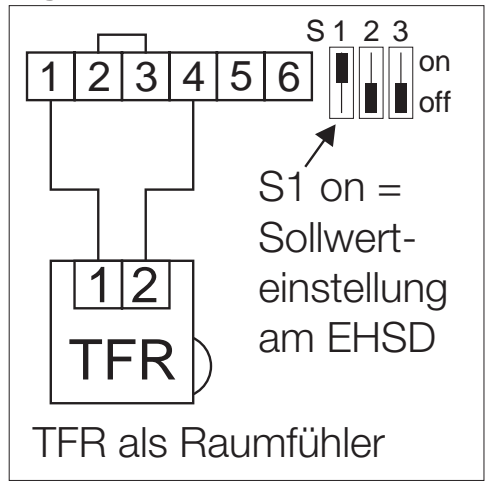

Fig. 4

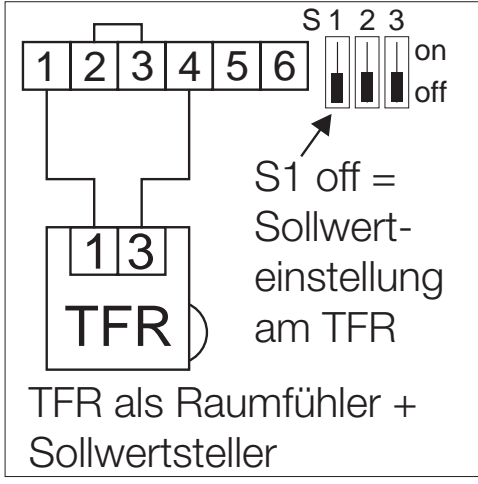

Fig. 5

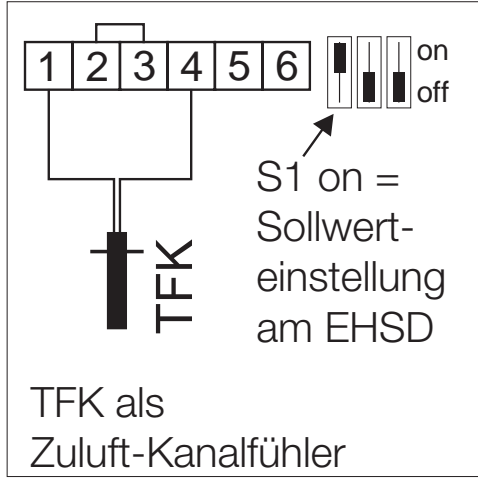

Fig. 6

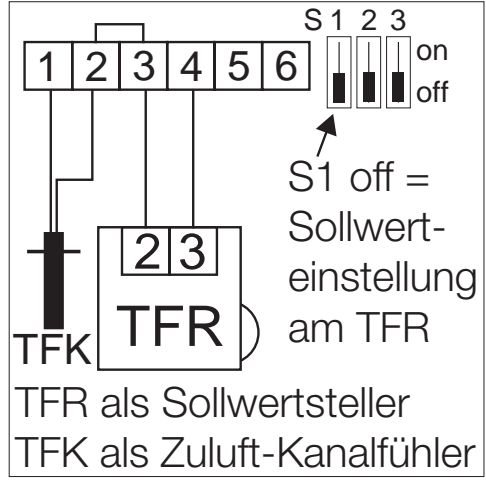

Fig. 7

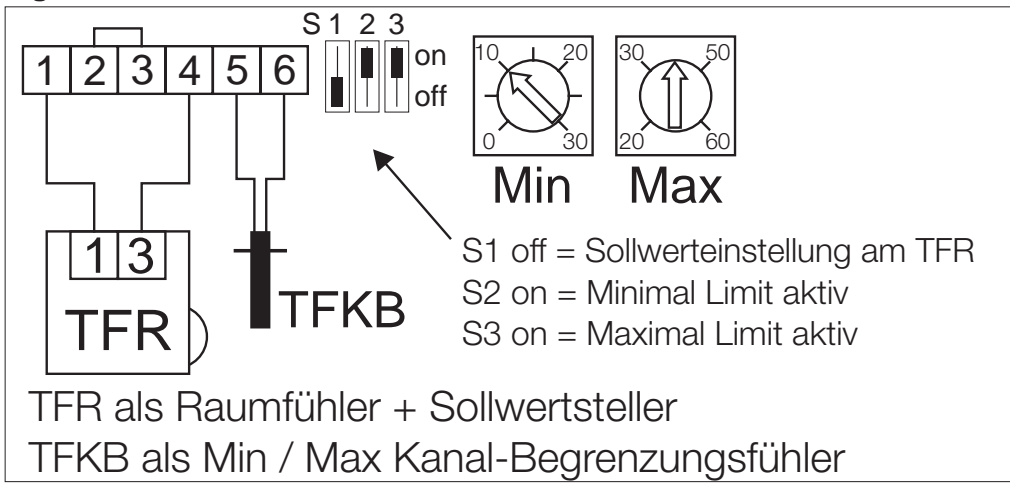

Fig. 8

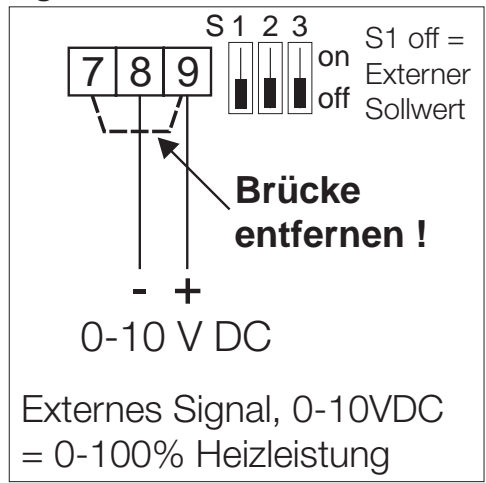

Fig. 9

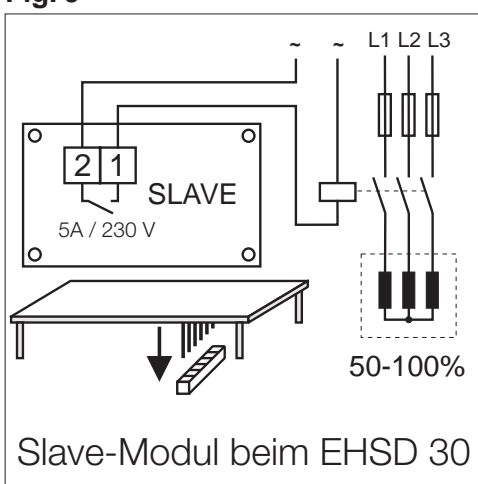

Fig. 10

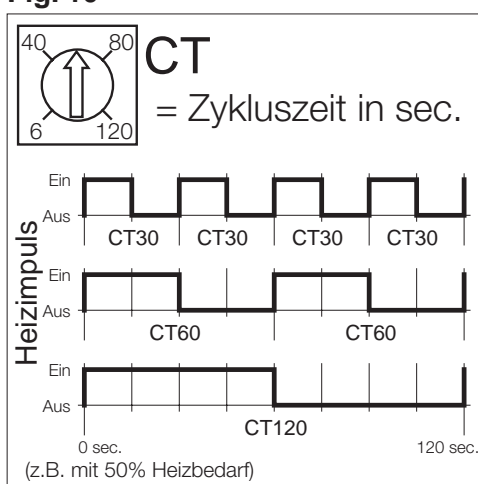

Fig. 11

S 1 2 3		
on		
off		
S1	on	interner Sollwert
	off	externer Sollwert
S2	on	minimal Limit aktiv
	off	min. Limit nicht aktiv
S3	on	maximal Limit aktiv
	off	max. Limit nicht aktiv