

SCHALTBILDER

DZR 20/2 B

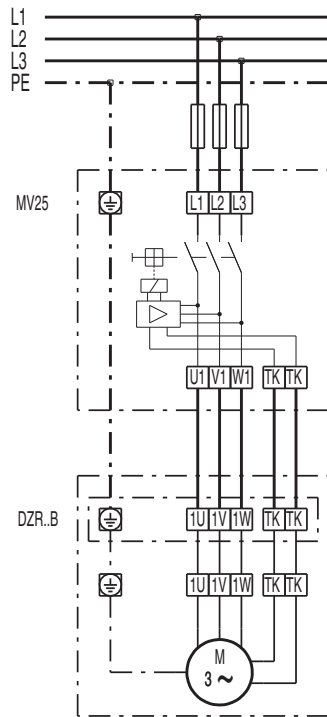

SCHALTBILDER

DZR 20/2 B

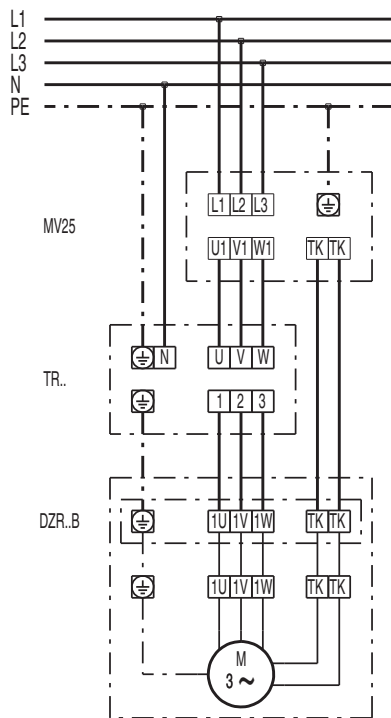

SCHALTBILDER

DZR 20/2 B

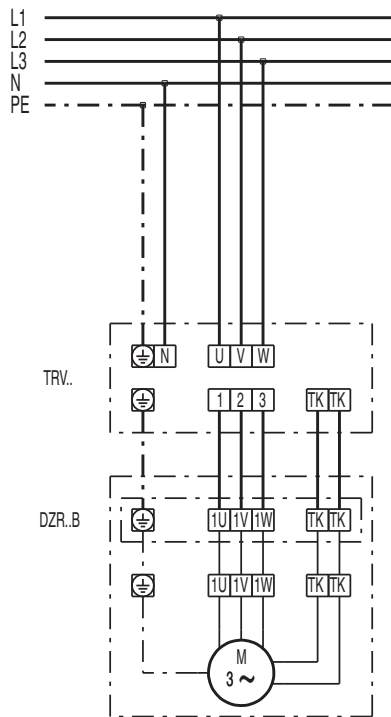

SCHALTBILDER

DZR 20/2 B

