

EZQ 20/2 B

EZQ / EZS..B Rechtslauf

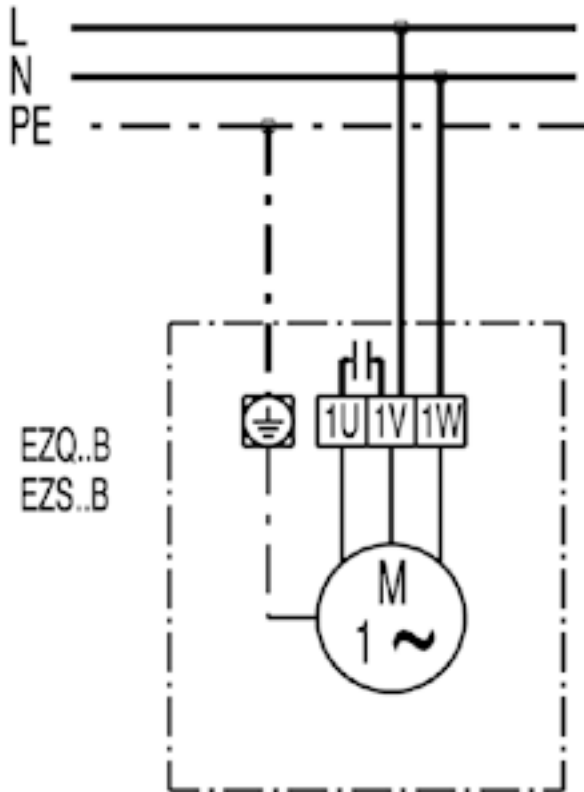

EZQ 20/2 B

EZQ / EZS..B Linkslauf

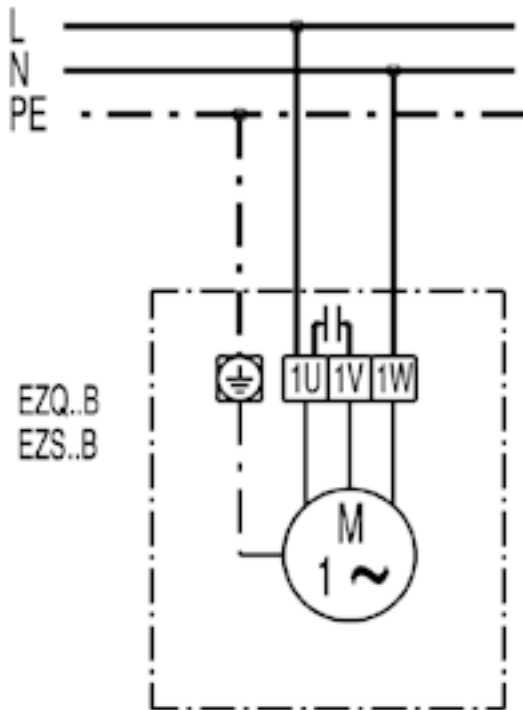

EZQ / EZS..B mit Drehzahlsteller ST / STU / STS Linkslauf

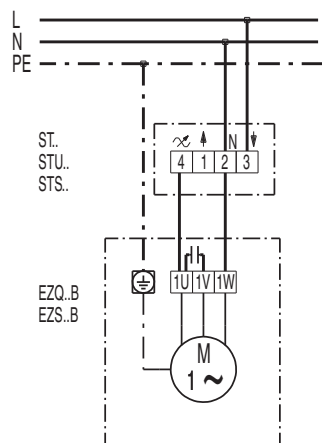

EZQ / EZS..B mit Drehzahlsteller STW1

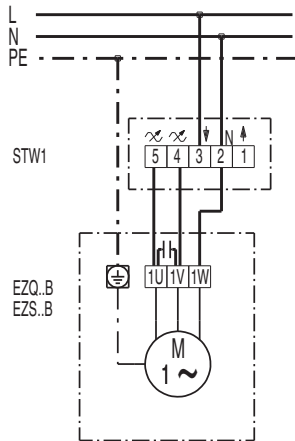

EZQ / EZS..B mit Wendeschalter UKW 1 und Drehzahlsteller STU..

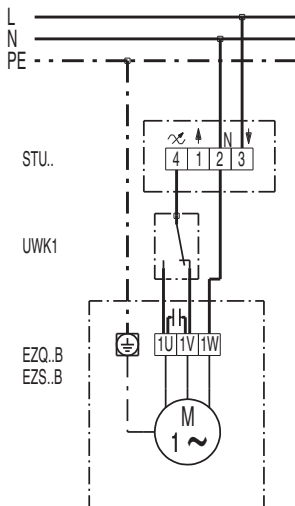

EZQ 20/2 B

EZQ / EZS..B mit 5-Stufentransformator TRE..S / Tr..S und 5-Stufenschalter ESS20

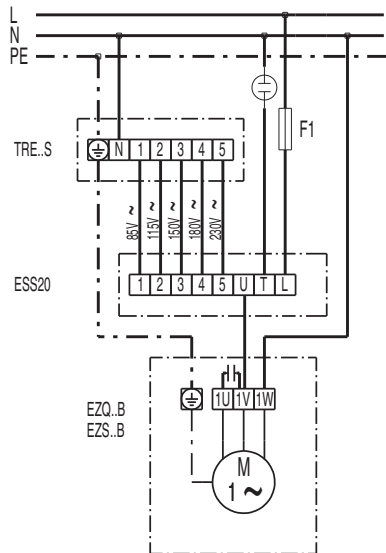

EZQ / EZS..B mit 5-Stufentransformator TRE..

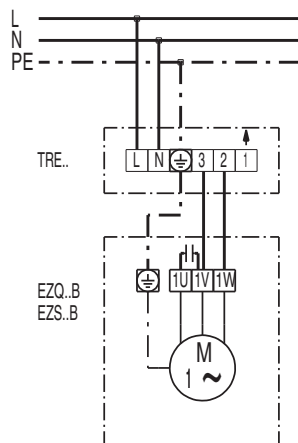

EZQ 20/2 B

EZQ / EZS..B mit Wendeschalter W1 / WU1

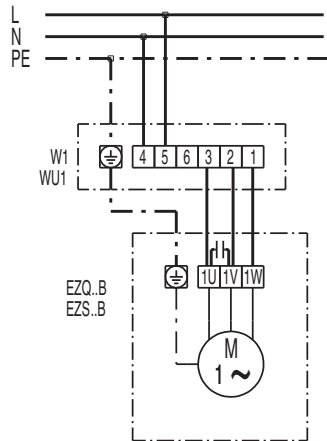

EZQ / EZS..B mit Wendeschalter FS 7

