

SCHALTBILDER

EZQ 25/2 B

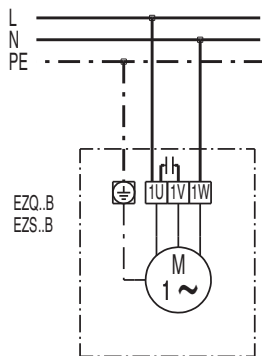
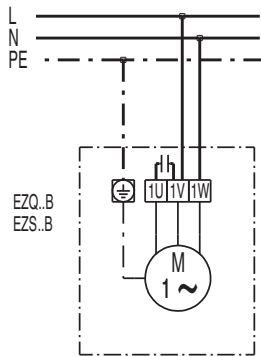

SCHALTBILDER

EZQ 25/2 B

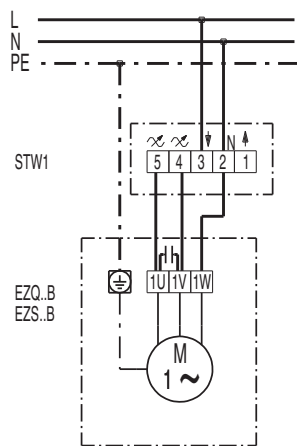
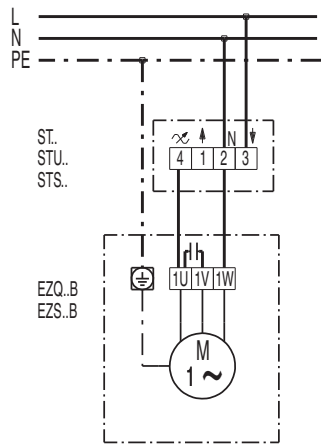

EZQ 25/2 B

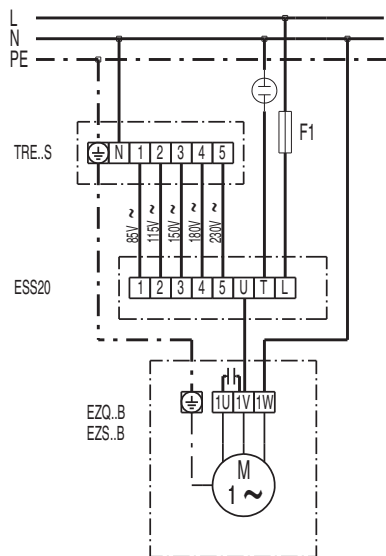
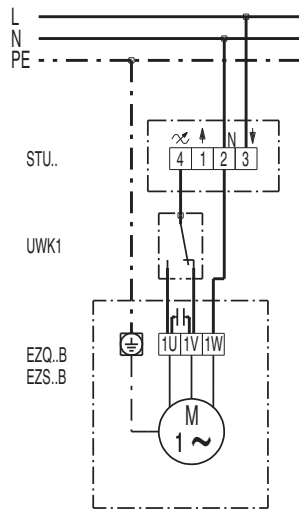

SCHALTBILDER

EZQ 25/2 B

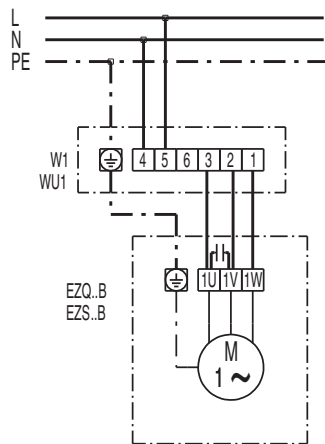
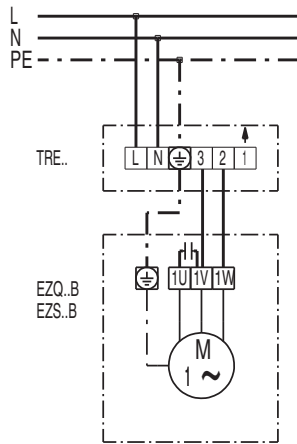

SCHALTBILDER

EZQ 25/2 B

