

SCHALTBILDER

EZS 40/6 B

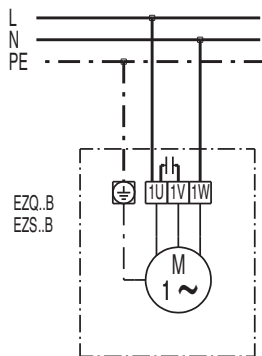

EZS 40/6 B

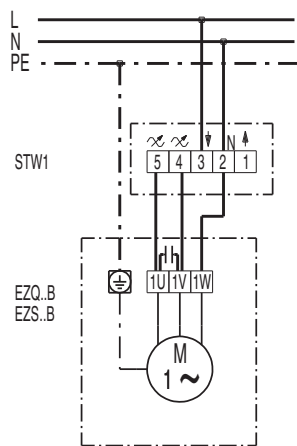
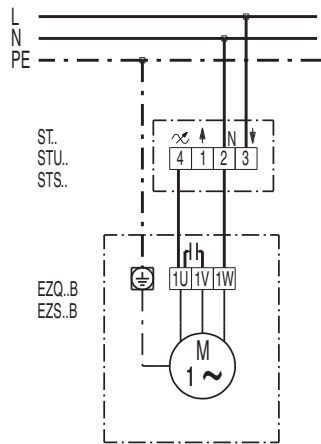

SCHALTBILDER

EZS 40/6 B

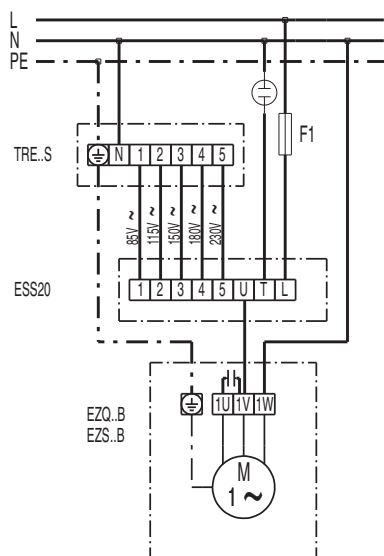
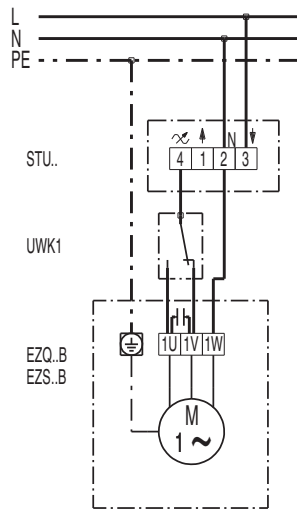

SCHALTBILDER

EZS 40/6 B

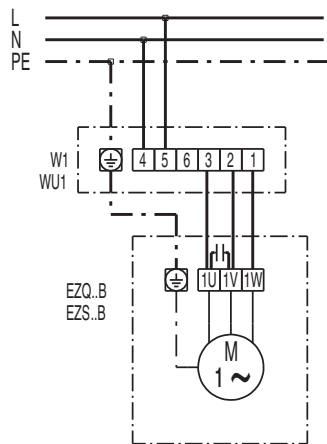
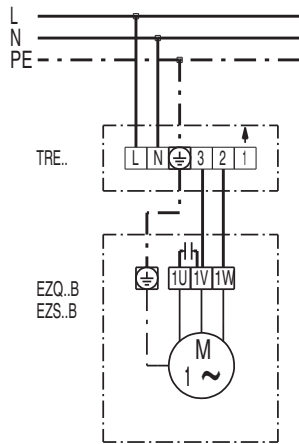

SCHALTBILDER

EZS 40/6 B

