

SCHALTBILDER

EZS 30/4 B

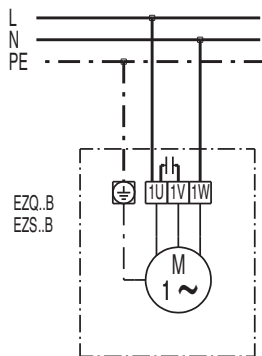

SCHALTBILDER

EZS 30/4 B

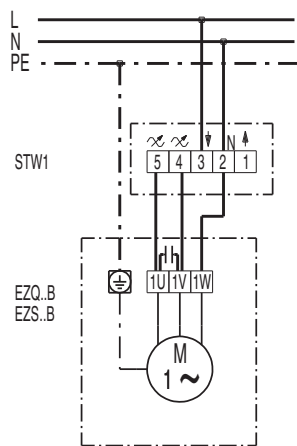
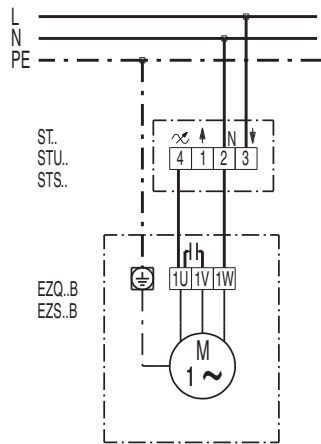

EZS 30/4 B

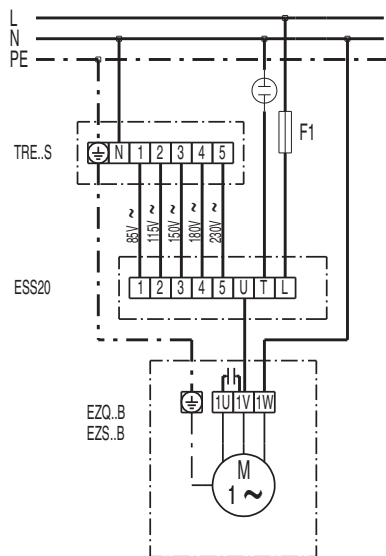
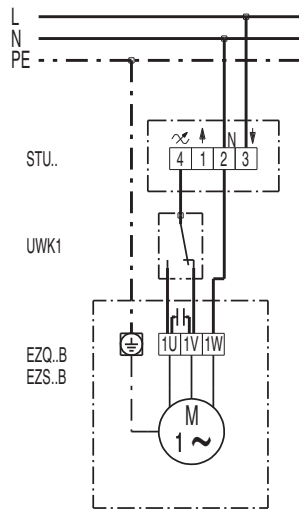

SCHALTBILDER

EZS 30/4 B

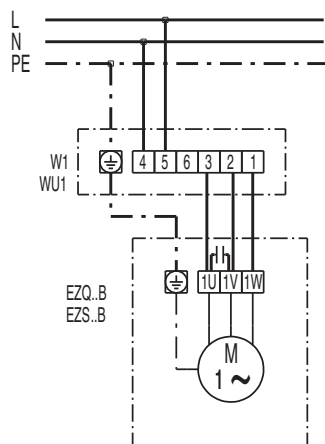
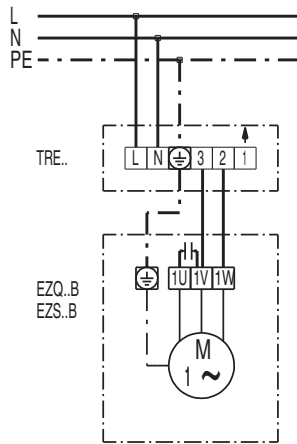

SCHALTBILDER

EZS 30/4 B

