

SCHALTBILDER

EZS 25/2 B

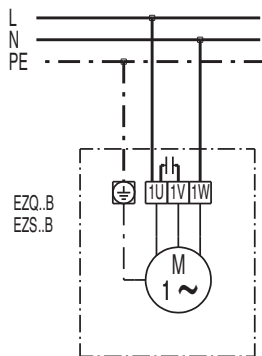

SCHALTBILDER

EZS 25/2 B

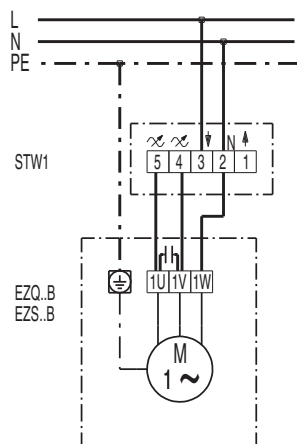
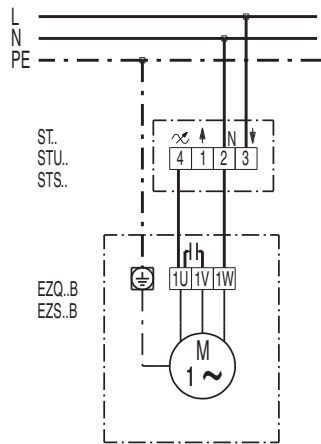

SCHALTBILDER

EZS 25/2 B

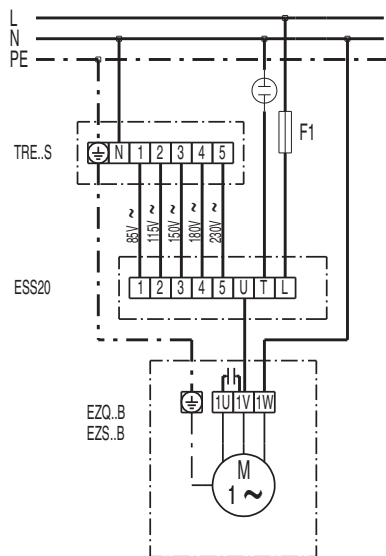
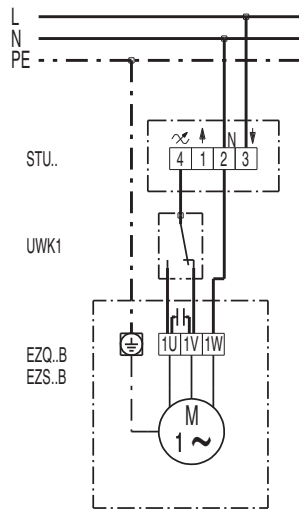

SCHALTBILDER

EZS 25/2 B

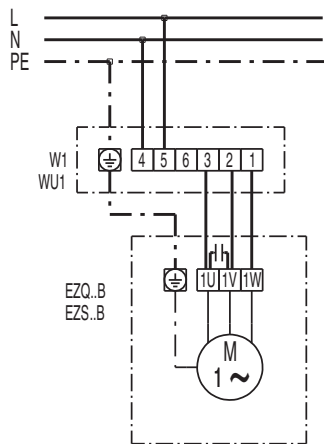
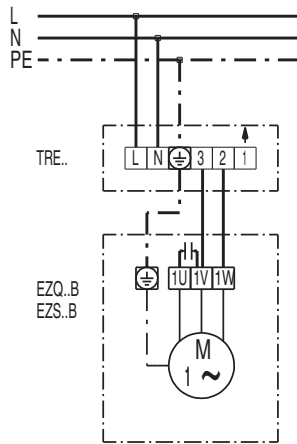

SCHALTBILDER

EZS 25/2 B

