

SCHALTBILDER

DZR 30/6 B

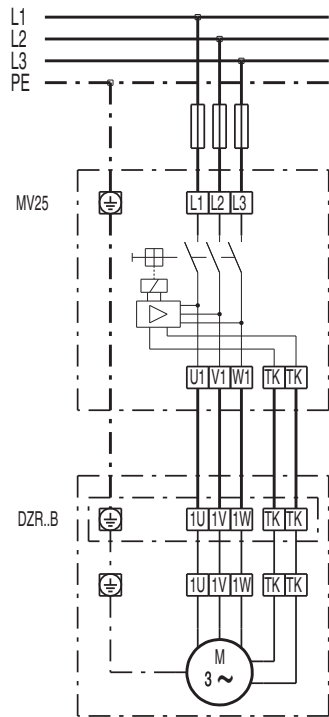

SCHALTBILDER

DZR 30/6 B

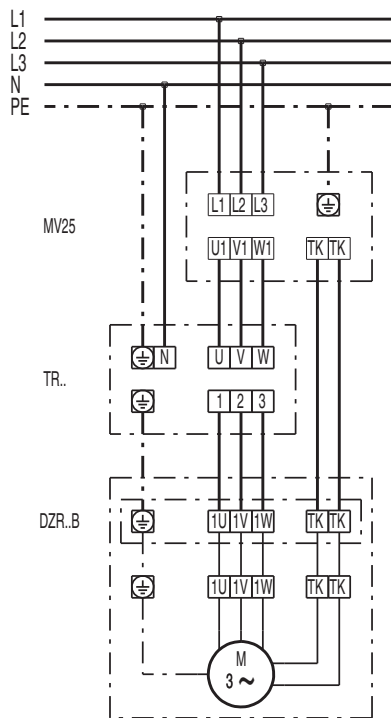

SCHALTBILDER

DZR 30/6 B

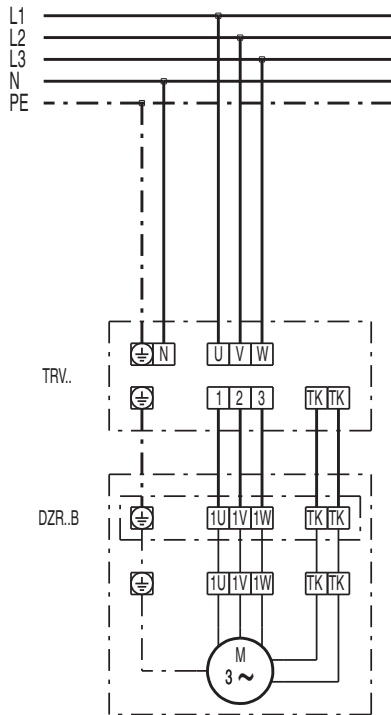

SCHALTBILDER

DZR 30/6 B

